

Correct Use



SR7D is a safety coupling relay/safety switchgear with seven safe relay contacts for fast and safe shutdown of hazardous plant components in the event of danger. It can be used in particular for furnaces and thermal process plants.

The device can be operated as a coupling relay for connection to safe semiconductor outputs (e.g. output of a safety PLC). Due to the integrated self-monitoring, no feedback loop is required for error monitoring.

The SR7D is specially designed and certified for the use on furnaces and thermal process plants in continuous operation according to EN 50156-1 and EN 746-2.

- 7 safety contacts
- 4 auxiliary contacts (relay); 2 solid-state auxiliary outputs
- Connection of sensors for:
 - temperature
 - pressure
 - volume flow
- Control: single or dual channel
- Can be used as emergency stop relay with separate safety circuit
- Feedback loop for external contactors or extension modules

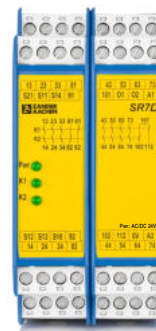

- Cyclical monitoring of the output contacts
- LED indicators for power and status channel 1 and 2
- 2 start modes:
 - monitored manual start
 - automatic start
- Short-circuit monitoring and earth fault monitoring
- Up to PL e, SILCL 3, category 4
- Stop category: 0

Function

The emergency stop safety switching device SR7D is designed for safe isolation of safety circuits according to EN 60204-1 and can be used up to SIL 3 according to IEC 61508 and safety category 4, PL e according to EN ISO 13849-1.

When the control signal is switched on or off, the safety contacts are closed or opened by the internal logic of the SR7D. The SR7D can also be used as a classic emergency-stop relay by appropriate wiring. In this case, the safety contacts are closed by closing the emergency stop circuit and a proper start command. Opening the emergency stop circuit immediately opens the safety contacts. It is ensured that a single fault does not lead to a loss of the safety function and that every fault is detected by cyclical self-monitoring no later than when the system is

switched off and switched on again. The operating status of the device is signalled via the semiconductor monitoring outputs O1 and O2 (reference potential: 0V terminal).

- O1: Device ready for operation, PWR (UB) applied.
- O2: Both relays K1 and K2 are switched on.

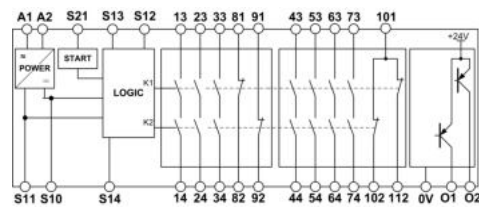

Fig. 1 Block diagram SR7D

Installation

As per EN 60204-1, the device is intended for installation in control cabinets with a minimum degree of protection of IP54. It is mounted on a 35 mm mounting rail according to EN 60715 TH35.

The load curves (see page 4) specify the maximum permissible total thermal current as a function of the ambient temperature.

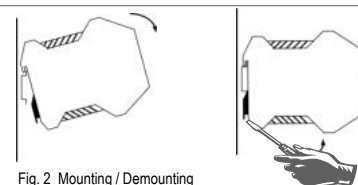

Fig. 2 Mounting / Demounting

Safety Precautions



- Installation and commissioning of the device must be performed **only by authorized personnel** and who has read and understood this operating instructions.
- Observe the country-specific regulations when installing the device.
- The electrical connection of the device is only allowed to be made with the device isolated.
- The wiring of the device must comply with the instructions in this operating instructions, otherwise there is a risk that the safety function will be lost.
- The contact protection and the insulation of the supply cables must be designed for the highest voltage to the device.

- It is not allowed to open the device, tamper with the device or bypass the safety devices.
- All relevant safety regulations and standards are to be observed.
- The overall concept of the control system in which the device is incorporated must be validated by the user.
- Failure to observe the safety regulations can result in death, serious injury and serious damage.
- Note down the version of the product (see label "Ver.") and check it prior to every commissioning of a new device. If the version has changed, the overall concept of the control system in which the device is incorporated must be validated again by the user.

Electrical Connection

- A safety transformer according to EN 61558-2-6 or a power supply unit with electrical isolation from the mains must be connected
- Observe the instructions in the section "Tech. Data"
- Use adequate protective circuit for inductive loads (e.g. free-wheeling diode)
- If the device does not function after commissioning, it must be returned to the manufacturer unopened. Opening the device will void the warranty
- The auxiliary outputs 81-82, 91-92, 101-102, 101-112 and O1, O2 may not be used as safety contacts

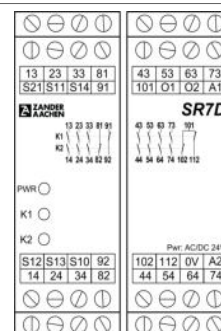

Fig. 3 Terminals

- A1: Power Supply
- A2: Power Supply
- S11: DC 24 V control voltage
- S10: Control line
- S12: Control line
- S13: Control line
- S14: Control line
- S21: Control line Start
- O1/O2: Solid-state aux. outputs
- 0V: Ref. potential O1/O2
- 81-82: Auxiliary contact
- 91-92: Auxiliary contact
- 101-102: Auxiliary contact
- 101-112: Auxiliary contact
- 13-14..
- 73-74: Safety contacts 1 to 7

User Manual

Applications

Depending on the application or the result of the risk assessment according to EN ISO 13849-1, the device must be wired as shown in Fig. 4 to Fig. 17.

Emergency Stop Circuit

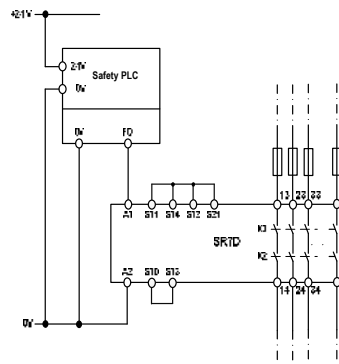

Fig. 4:
Single channel control via safe output "FO" ("Safe coupling relay" application). (Category 4, up to PL e / SIL 3; Condition: Safe output "FO" meets PL e, SIL 3 and wiring is done in a protected wiring compartment with a minimum degree of protection of IP54).

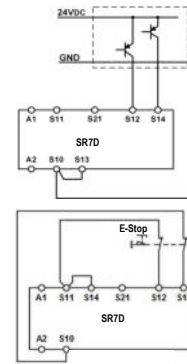

Fig. 5:
Two channel emergency stop with PNP outputs / OSSD outputs **with its own** short circuit monitoring. (Category 4, up to PL e / SIL 3)

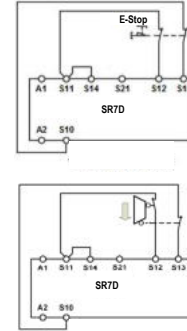

Fig. 6:
Dual channel emergency stop with short circuit and ground fault monitoring. (Category 4, up to PL e / SIL 3)

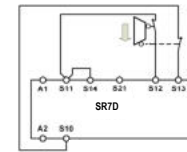

Fig. 8:
Dual channel safety guard monitoring with short circuit and ground fault monitoring. (Category 4, up to PL e / SIL 3)

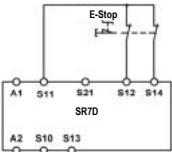

Fig. 7:
Dual channel emergency stop with ground fault monitoring. (Category 3, up to PL d / SIL 2)

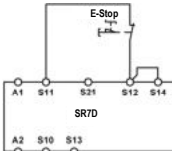

Fig. 9:
Single channel emergency stop with ground fault monitoring. (Category 1, up to PL c / SIL 1)

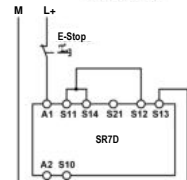

Fig. 10:
Single channel emergency stop without fault-detection of the safety switch and the wires. (Category 1, up to PL c / SIL 1)

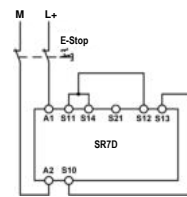

Fig. 11:
Dual channel emergency stop without fault-detection of the safety switch and the wires. (Category 3, up to PL d / SIL 2)

Attention:

- To activate earth fault monitoring, PE must only be connected to the power supply unit in accordance with EN 60204-1.
- It must be ensured that any switch-on pulses sent by the signal generator (light test) do not cause the safety relay to be activated for a short time and should therefore always be deactivated.
- For applications according to Fig. 10 and Fig. 11 it must be ensured that the reference potential of the signal generator and the SR7D is the same.

Start Behaviour

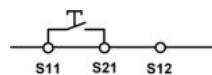

Fig. 12:
Monitored manual start. It is monitored that the start button has been opened before the safety switch is closed. (Condition: power supply may not be interrupted)



Fig. 13:
Automatic start. Maximum allowable delay when closing the safety switches at S12 and S13: S12 before S13: 300ms S13 before S12: no limit

Warning:
Safety contacts will be activated immediately at power-on.

Feedback Loop

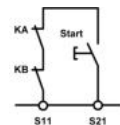

Fig. 14:
Feedback loop for monitored manual start: The feedback loop monitors contactors or the expansion modules.

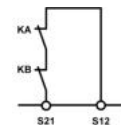

Fig. 15:
Feedback loop for automatic start: The feedback loop monitors contactors or the expansion modules.

Power supply and Safety contacts

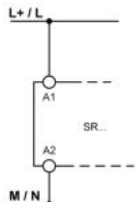

Fig. 16:
Power supply at A1 and A2. (Power supply according to techn. Data)

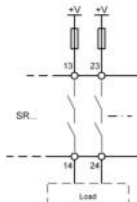

Fig. 17:
Connecting load to safety contacts. (Figure shows example. Voltage „+V“ according to techn. Data)

Commissioning Procedure

Advice: Follow the guidelines in „Electrical Connection“ during the start-up.

1. Input circuit:

Depending on the risk evaluation choose one of the wiring diagrams in „Applications“ (Fig. 4 to 11).

2. Choose start mode:

Connect the start button with S11 and S21 for monitored manual start or connect S21 with S12 directly for automatic start (Fig. 12 or 13).

Warning:

If “Automatic start” is set, bear in mind that the safety contacts will switch immediately after the power supply is

connected. If “Monitored manual start” is set, the start button must be opened after wiring.

3. Feedback loop:

If external contactors or extension modules are used, connect them according to Fig. 14 or Fig. 15.

4. Power supply:

Connect the power supply to A1 and A2 (Fig. 16 or Fig. 10 or Fig. 11).

Caution: Power must not yet be activated.



5. Starting the device:

Switch on the operating voltage.

Warning:

If the "Automatic start" starting behaviour is set, the safety contacts will close immediately.

If the "Monitored manual start" starting behaviour is set, close the start button to close the safety contacts. LEDs **K1** and **K2** are lit.

6. Triggering safety function:

Open the emergency stop circuit by actuating the connected safety switch. The safety contacts open immediately.

7. Reactivation:

Switch the device on again as described under 5.

What to do in Case of a Fault?

Device does not switch on:

- Check the wiring by comparing it to the wiring diagrams.
- Check the safety switch for correct function and adjustment.
- Check whether the safety inputs are activated.
- Check whether the start button (manual start) is closed.
- Check the operating voltage at A1 and A2.
- Is the feedback loop closed?

Device cannot be switched on after a safety request:

- Emergency stop circuit was closed again.
- Was the start button opened before closing of the emergency stop circuit (manual start)?
- Is the feedback loop closed?

If the fault still persists, perform the steps listed under "Commissioning Procedure". If these steps do not remedy the fault either, return the device to the manufacturer.

Opening the device is not permitted and will void the warranty.

Techn. Data

In compliance with	EN 60204-1; EN ISO 13849-1; IEC 62061; EN 50156-1; EN 746-2; IEC 61508 parts 1-2 and 4-7; IEC 61511-1
Operating voltage	AC/DC 24 V, AC: 50-60 Hz
Allowable tolerance	+ 10 % / - 10 %
Power consumption	UB = DC 24 V: ca. 5 W / UB = AC 24 V: ca. 9,7 VA
Control voltage at S11	DC 24 V
Current consumption of the inputs	S12: < 80 mA, S13 or S14: < 120 mA, S21: < 80 mA
Test pulse suppression:	
Dark test (test pulse width / pause between test pulses)	≤ 5 ms / ≥ 200 ms
Light test (test pulse width / pause between test pulses)	≤ 0,5 ms / ≥ 200 ms
	ATTENTION: It must be ensured that light test pulses generated by the signal generator do not lead to a short activation of the safety relays. Therefore, it is recommended that light test pulses are deactivated by default, provided that they are not necessary for the safety level to be achieved.
Safety contacts	7 NO (each with 2 redundant relay contacts)
Auxiliary outputs	4 NC (relay contacts) + 2 solid-state PNP outputs
Maximum switching voltage	AC 250 V
Contact rating of safety contacts (13-14, 23-24, 33-34, 43-44, 53-54, 63-64, 73-74) 6 switching cycles per minute	AC: 250 V, 2000 VA, 8 A for resistive load 250 V, 3 A for AC-15 DC: 30 V, 240 W, 8 A for resistive load 24 V, 3 A for DC-13 Maximum cumulative current: see load curves at page 4
Contact rating of auxiliary contacts (81-82, 91-92, 101-102, 101-112)	AC: 250 V, 500 VA, 2 A for resistive load DC: 30 V, 60 W, 2 A for resistive load
Minimum contact load	5 V, 10 mA 10 A gG
External fuses for safety contacts	6 A gG for applications acc. to EN 50156-1 (see chapter 10.5.5.3.4)
Solid state auxiliary outputs	switching +24 V (PNP), max. 30 mA, short-circuit proof
Wire width	0.14 mm ² to 2.5 mm ²
Tightening moment (min. / max.)	0.5 Nm / 0.6 Nm
Maximum switch-on delay	30 ms
Maximum delay when requesting the safety function	via S11-S12 or S11-S14/S10-S13: 10 ms, via A1/A2: 25 ms
Maximum resistance of the control lines (incl. switches / sensor)	40 Ω at nominal operating voltage (DC 24 V)
Contact material	AgSnO ₂
Service life	mech. approx. 1 x 10 ⁷
Rated impulse withstand voltage	2.5 kV (control voltage / contacts)
Dielectric strength	4 kV (acc. to EN 60664-1)
Rated insulation voltage	250 V
Degree of protection	IP20
Temperature range	-15 °C to +55 °C (Pay attention to load curves, see page 4)
Storage temperature	-15 °C to +80 °C
Max. altitude	≤ 2000 m (above sea level)
Degree of pollution / Overvoltage category	2 / 3 (acc. to EN 60664-1)
Weight	approx. 350 g
Mounting	Mounting rail acc. to EN 60715 TH35

User Manual

Check and Maintenance

The following checks are regularly required to ensure proper and continuous functioning:

- Check the switch function
- Check for signs of manipulation and safety function bypassing
- Check if the device is mounted and connected securely

- Check for soiling

Check if the safety device is working properly, in particular:

- Every time after initial commissioning
- Every time after replacing a component
- After every fault in the safety circuit

According to CNB/M/11.050, a request for the safety function is recommended at the following intervals:

- Once a month for applications up to PL e with Cat. 3 or Cat. 4, or SIL CL 3 / SIL 3 with HFT = 1
- Once per year for applications up to PL d with cat. 3, or SIL CL 2 / SIL 2 with HFT = 1

Disclaimer and Warranty

Failure to comply with the above conditions for proper use, failure to follow the safety instructions or failure to carry out any maintenance work as required will result in a disclaimer of liability and loss of warranty.

tic measures register a dangerous state, e.g. caused by a component fault.

Since process applications in particular have high availability requirements, limited availability can also have considerable consequences.

It is therefore recommended to stock a second unit to avoid long downtimes in such a case.

These are recommendations of the manufacturer, the evaluation of the importance of the system availability is solely the responsibility of the operator.

ATTENTION

Please be aware that it is the sole responsibility of the operator to ensure system availability.

The SR7D is a safety switchgear according to

- EN ISO 13849-1
- IEC 62061
- IEC 61508
- EN 50156-1
- EN 746-2
- IEC 61511-1

which branches to the safe state when the safety function is requested.

This means that the connected load is switched off as soon as a request is initiated via connected sensors, or diagnos-

Load Curves

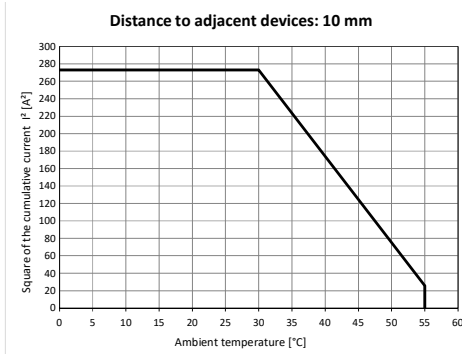
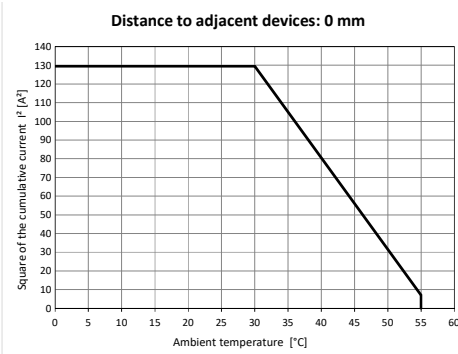

Square of the cumulative current:

$$\sum I^2 = (I_1)^2 + (I_2)^2 + (I_3)^2 + (I_4)^2 + (I_5)^2 + (I_6)^2 + (I_7)^2$$

with (I₁) - (I₇): Currents in the safety contact paths

Dimension Drawing

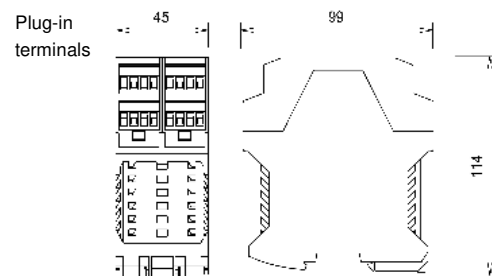
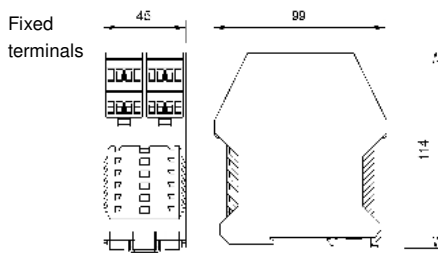

Variants

Order No. 472243	SR7D, AC/DC 24 V (AC: 50-60 Hz),	fixed screw terminals
Order No. 474243	SR7D, AC/DC 24 V (AC: 50-60 Hz),	incl. plug-in screw terminals
Order No. 475243	SR7D, AC/DC 24 V (AC: 50-60 Hz),	incl. push-in twin spring connector
Order No. 472592	EKLS4	set plug-in screw terminals
Order No. 472595	EKLZ4	set push-in twin spring connector
Order No. 472596	Spacer for a defined minimum distance between two safety relays (see load curves)	

Safety characteristics according to EN ISO 13849-1

Load - AC-15 / DC-13	≤ 1 A / ≤ 1 A	≤ 2A / ≤ 2A	≤ 3A / ≤ 3A
Max. duration of use [Years]	20	20	20
Category	4	4	4
PL	e	e	e
PFHd [1/h]	1.2E-08	1.2E-08	1.2E-08
nop [Cycles / year] - AC-15 / DC-13	≤ 50,000 / ≤ 350,000	≤ 35,000 / ≤ 100,000	≤ 35,000 / ≤ 15,000

Safety characteristics according to IEC 61508 - High Demand

Conditions: Days of operation/year: 365; Hours/Day: 24; Switching-Cycle/Hour: 1,7; Maximum load AC-15 / DC-13

Max. duration of use [Years]	20
Proof-Test-Intervall [Years]	20
PFH	2.4E-10
SIL	3

Safety characteristics for alternate 1oo1 structure for process industry - High Demand

Conditions: Days of operation/year: 365; Hours/Day: 24; Switching-Cycle/Hour: 1,7; Maximum load AC-15 / DC-13

Device type	A
HFT	0
SIL	3
SFF [%]	99.91
λ _{SD} [FIT]	0
λ _{SU} [FIT]	185.3
λ _{DD} [FIT]	17.33
λ _{DU} [FIT]	0.17
PFH [1/h]	2.4E-10

Safety characteristics according to IEC 61508 - Low Demand

Conditions: Maximum load AC-15 / DC-13

Max. duration of use [Years]	20
Proof-Test-Intervall [Years]	5
PFD _{AVG}	1.12E-04
SIL	3

Safety characteristics for alternate 1oo1 structure for process industry - Low Demand

Conditions: Maximum load AC-15 / DC-13

Device type	A
HFT	0
SIL	3
SFF [%]	91.58
λ _{SD} [FIT]	0
λ _{SU} [FIT]	92.59
λ _{DD} [FIT]	0
λ _{DU} [FIT]	8.51
PFD _{AVG} (e.g. for T = 1 year)	3.73E-05

Proof-Test



In order to check the correct function of the device, the following steps must be carried out

- Trigger the safety function via the safety circuit. Check that the safety outputs (13-14; 23-24; 33-34; 43-44; 53-54; 63-64; 73-74) have been opened by triggering the safety function.
- Now reactivate the device by closing the safety circuit again and, if configured, trigger a start command. Check that the safety outputs (13-14; 23-24; 33-34; 43-44; 53-54; 63-64; 73-74) are closed again.

If the unit does not switch on again, the proof test has not been passed.

ATTENTION:

If the proof test is not passed, the device must be replaced. Otherwise there is a hazard of loss of functional safety.